

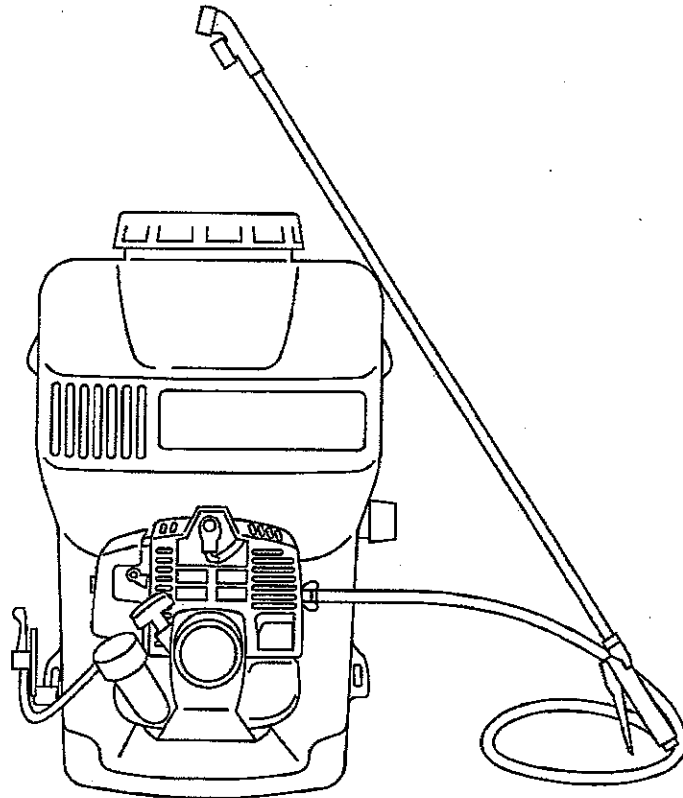

MS036 BACK PACK POWER SPRAYER



Owner's/Operator's Manual

Completely read and understand this manual before using this product.

TABLE OF CONTENTS

TOPIC	PAGE
1. Foreword	2
2. Safty Symbols	2
3. Limited Warranty Statement	3
4. WARNING	6
5. Safty Precautions for Applying Chemicals	7
6. Assembly Instructions	8
7. Assembling	9
8. Preparations for Starting	9
9. Operating Instructions	11
10. Regular Maintenance	14
11. Storage	15
12. Emission Control Information	16
13. Fuel Recommendations	17
14. Maintenance	18
15. Trouble shooting	19
16. Specification	21

FOREWORD

This Owner's/Operator's Manual is designed to familiarize the operator with the various features and component parts of the equipment and to assist you with the assembly, operation and maintenance of your new BACK PACK POWER SPRAYER.

It is essential that any operator of this BACK PACK POWER SPRAYER reads and understands this manual before using the BACK PACK POWER SPRAYER.

Important safety instructions will be identified by the following safety symbol:



Failure to comply with the instructions in this manual may result in serious injury or death. For additional assistance, contact any local authorized Maruyama dealer or Maruyama U.S., Inc., 301 – 30th St. NE, Suite 118, Auburn, WA 98002.

MANUAL SAFETY SYMBOLS

Throughout this manual and on the product itself, you will find safety alerts and helpful, information message preceded by symbols or key words. The following is an explanation of those symbols and key words and what they mean to you.



This symbol accompanied by the words **WARNING** and **DANGER** calls attention to an act or condition that can lead to serious personal injury to operator and bystanders.



Limited Warranty Statement

All Maruyama products are warranted to the original purchaser to be free from defects in material and workmanship **from the date of purchase** for the time periods listed as follows:

Lifetime for inner drive shafts on trimmers and brushcutters and all ignition modules. **3 years** for residential, non-institutional, non-income producing use. **1 years** for industrial, commercial, institutional, rental and income producing use. **Refer to the Engine manufacture warranty statement for Engine warranty information.**

Any part of a Maruyama product found to be defective within the applicable warranty period shall, at Maruyama's option, be repaired or replaced without charge. Warranty consideration is obtained by delivering any Maruyama product believed to be defective to an Authorized Maruyama Servicing Dealer within the applicable warranty period.

The purchaser shall not be charged for diagnostic labor that leads to the determination that a warranted part is defective, if the diagnostic work is performed at a Maruyama Dealer.

Any warranted part which is not scheduled for replacement as required maintenance, or which is scheduled only for regular inspection to the effect of "repair or replace as necessary" shall be warranted for the warranty period. Any warranted part which is scheduled for replacement as required maintenance shall be warranted for the period of time up to the first scheduled replacement point for that part. Maruyama Mfg. Co., Inc. is liable for damages to other engine components caused by the failure of a warranted part still under warranty. The purchaser is responsible for the performance of the required maintenance, as defined by Maruyama Mfg. Co., Inc. in the Owner's/Operator's Manual.

EMISSION-RELATED PARTS WARRANTY: In addition to the above warranty coverage, Maruyama Mfg. Co., Inc. will repair or replace, free of charge, for the original purchaser and each subsequent purchaser any emission-related part or parts found to be defective in material and workmanship for two (2) years from original retail delivery date. **Emission-related parts are the carburetor assembly, the ignition coil assembly, the ignition rotor and the spark plug.** Any replacement part that is equivalent in performance and durability may be used in non-warranty maintenance or repairs, and shall not reduce the warranty obligations of Maruyama Mfg. Co., Inc.

This warranty does not cover the following:

1. Maintenance items (excluding defects in materials and workmanship) including hoses, spark plugs, starter rope, air and fuel filters, vibration isolators, throttle cables and all cutting attachments.
2. Extra expenses including shipping and handling, travel, payment for lost time or pay and for any inconvenience and storage.
3. Alterations or modifications including aftermarket parts not authorized by Maruyama U.S., Inc.
4. Wear, accident, abuse, neglect, misuse, negligence, improper fuels, lubricants, fuel mixtures (when applicable), or failure to operate or maintain the product in accordance with instructions approved by Maruyama.

Repair or replacement as provided under this warranty is the exclusive remedy of the consumer. Maruyama shall not be liable for any incidental or consequential damages for breach of any express or implied warranty on these products except to the extent prohibited by applicable law. Any implied warranty of merchantability or fitness for a particular purpose on these products is limited in duration to the warranty period as defined in the limited warranty statement. Maruyama reserves the right to change or improve the design of the product without notice and does not assume obligation to update previously manufactured products.

This warranty provides you with specific legal rights which may vary from state to state.

It is the Owner's and Dealer's responsibility to make sure the Warranty Registration Card is properly filled out and mailed to Maruyama U.S., Inc. Proof of purchase and registration will be required in order to obtain warranty service.

To locate an Authorized Maruyama Servicing Dealer nearest you, contact Maruyama U.S., Inc. at **1-253-735-7368**.

Maruyama U.S., Inc.
PO Box 309
Auburn, WA 98071-0309

Effective 06/01/1999

MARUYAMA LIMITED WARRANTY CALIFORNIA AND FEDERAL EMISSION CONTROL SYSTEMS LAWN AND GARDEN AND UTILITY ENGINES

The California Air Resources Board, the Environmental Protection Agency (EPA), and Maruyama U.S., Inc. (hereinafter "Maruyama") are pleased to explain the Emission Control System Warranty on your Maruyama Lawn and Garden and Utility engine. In California, new Lawn and Garden and Utility engines produced after January 1, 1995 must be designed, build and equipped to meet the state's stringent anti-smog standards. In other states, new 1997 and later model your Lawn and Garden and Utility engines must meet the U.S. EPA Phase One regulations for small non-road engines. Maruyama must warrant the emission control system on your Lawn and Garden Utility engine for the period of time listed below provided there has been no abuse, neglect or improper maintenance of your Lawn and Garden and Utility engine. Your emission control system may include parts such as the carburetor and ignition system. Also included may be hoses, belts, connectors and other emission related assemblies that are a part of the Lawn and Garden and Utility engine. Where a warrantable condition exists, Maruyama will repair your Lawn and Garden and Utility engine at no cost to you including diagnosis (if the diagnostic work is performed at a Maruyama Lawn and Garden and Utility engine dealer), parts and labor.

OWNERS WARRANTY RESPONSIBILITIES: The following obligations must be fulfilled by the owner to maintain the validity of the Maruyama California / EPA Phase One Emissions Systems Warranty:

- (a) As the Lawn and Garden and Utility engine owner, you are responsible for the performance of the **required maintenance listed in your owner's manual**. Maruyama recommends that you retain all receipts covering maintenance on your Lawn and Garden and Utility engine, but Maruyama cannot deny warranty solely for the lack of receipts or for your failure to ensure the performance of all scheduled maintenance.
 - (b) You are responsible for presenting your Lawn and Garden and Utility engine to an authorized Maruyama Lawn and Garden and Utility engine dealer as soon as a problem exists. The warranty repairs should be completed in a reasonable amount of time, not to exceed 30 days.
 - (c) As the Lawn and Garden and Utility engine owner, you should also be aware that Maruyama may deny you warranty coverage if your Lawn and Garden and Utility engine or a part has failed due to abuse, neglect, improper maintenance or unapproved modifications.
 - (d) If you have any questions regarding your warranty rights and responsibilities, you should contact Maruyama U.S., INC., Product and Marketing Division, 15436 N.E. 95th St, Redmonds, WA 9805 (425) 885-0811 or in the case of California residents, you may contact, the California Air Resources Board, 9528 Telstar Avenue, EL Monte, California 91731.
1. **COVERAGE.** Maruyama warrants to the initial owner and each subsequent purchaser that the Lawn and Garden and Utility engine is free from defects in materials and workmanship which cause a failure of a warranted part for a period of two years. Maruyama is liable for damages to other engine components caused by the failure of a warranted part still under warranty. The 1995 and later model year Lawn and Garden and Utility engines are warranted part still under warranty. In all other states, 1997 and later model year Lawn and Garden and Utility engines are warranted for two years. If any emission-related part on your engine is defective, the part will be repaired or replaced by Maruyama. This warranty time period shall begin on the date the Lawn and Garden and Utility engine is delivered to the initial purchaser, or on the date the Lawn and Garden and Utility engine is first placed in serves.

CONTINUED

Warranty defects shall be remedied during customary business hours at any authorized Maruyama Lawn and Garden and Utility engine dealer located within the United States of America. Any manufacturer-approved replacement part may be used in the performance of any warranty maintenance or repairs on emission-related parts, and must be provided without charge to the owner if the part is still under warranty. Any part or parts replaced under this warranty shall become the property of Maruyama.

The emission related warranted parts are specifically defined by the California Air Resources Board's Emission Warranty Parts List. (EPA's regulations do not include a parts list, but EPA considers emission-related parts to include all parts listed here.) These warranted parts are: carburetor and internal parts, spark advance/retard system, cold start enrichment system, magneto or electronic ignition system, air cleaner element, and spark plugs if failure occurs prior to the first required scheduled replacement, hoses, clamps, fittings, gaskets, sealing devices, mounting hardware and tubing used directly in these parts. Since emission related parts may vary slightly from model to model, certain models may not contain all of these parts and certain models may contain functionally equivalent parts.

2. LIMITATIONS. This Emission Control System Warranty shall not cover any of the following:

- (a) Repair or replacement required as a result of (i) misuse or neglect, (ii) lack of required maintenance, (iii) repairs improperly performed or replacements improperly installed, (iv) use of replacement parts or accessories not conforming to Maruyama specifications which adversely affect performance and/or durability, (v) alterations or modifications not recommended or approved in writing by Maruyama.
- (b) Replacement of parts and other services and adjustments necessary for required maintenance at and after the first scheduled replacement point.

3. LIMITED LIABILITY.

- (a) The liability of Maruyama under this Emission Control Systems Warranty is limited solely to the remedying of defects in materials or workmanship by any authorized Maruyama Lawn and Garden and Utility engine dealer at its place of business during customary business hours. This warranty does not cover inconvenience or loss of use of the Lawn and Garden and Utility engine or transportation of the Lawn and Garden and Utility engine to or from the Maruyama dealer. MARUYAMA SHALL NOT BE LIABLE FOR ANY OTHER EXPENSE, LOSS OR DAMAGE, WHETHER DIRECT, INCIDENTAL, CONSEQUENTIAL (EXCEPTION LISTED UNDER COVERAGE) OR EXEMPLARY ARISING IN CONNECTION WITH THE SALE OR USE OF OR INABILITY TO USE THE MARUYAMA LAWN AND GARDEN AND UTILITY ENGINE FOR ANY PURPOSE.
- (b) NO EXPRESS EMISSION CONTROL SYSTEMS WARRANTY IS GIVEN BY MARUYAMA WITH RESPECT TO THE MARUYAMA LAWN AND GARDEN AND UTILITY ENGINE EXCEPT AS SPECIFICALLY SET FORTH HEREIN. ANY EMISSION CONTROL SYSTEMS WARRANTY IMPLIED BY LAW, INCLUDING ANY WARRANTY OF MERCHANTABILITY OR FITNESS FOR A PARTICULAR PURPOSE, IS EXPRESSLY LIMITED TO THE EMISSION CONTROL SYSTEMS WARRANTY TERMS SET FORTH HEREIN. THE FOREGOING STATEMENTS OF WARRANTY ARE EXCLUSIVE AND IN LIEU OF ALL OTHER REMEDIES.
- (c) No dealer is authorized to modify this Maruyama Limited Emission Control Systems Warranty.
- (d) Maruyama is not liable for parts which are not genuine Maruyama parts except when genuine Maruyama parts cause damage to non-Maruyama parts.

4. LEGAL RIGHTS. THIS WARRANTY GIVES YOU SPECIFIC LEGAL RIGHTS, AND YOU MAY ALSO HAVE OTHER RIGHT.

5. THIS WARRANTY IS IN ADDITION TO THE MARUYAMA LIMITED LAWN AND GARDEN AND UTILITY ENGINE WARRANTY.

Effective 06/01/1999

 **WARNING** 

- 1) Read and understand the owner's manual before using the BACK PACK POWER SPRAYER. Be thoroughly familiar with the proper use of the sprayer.
- 2) Never allow children to operate the BACK PACK POWER SPRAYER. It is not a toy. Never allow adults to operate the unit without first reading the owner's/operators manual.
- 3) Become familiar with the controls and know how to stop the engine quickly.
- 4) Always use eye protection and hearing protection.
- 5) Keep the area of operation clear of all persons, particularly small children and pets.
- 6) Do not point the discharge hose in the direction of children or pets.
- 7) Never operate BACK PACK POWER SPRAYER when you are fatigued.
- 8) Never operate BACK PACK POWER SPRAYER without proper guards or other protective safety devices in place.
- 9) Dress properly. Do not wear loose clothing or jewelry that can be caught in moving parts. Always wear substantial footwear, long pants, and long sleeved shirt.
- 10) Gasoline is highly flammable, handle it carefully.
 - a) Do not smoke while handling gasoline.
 - b) Use an approved fuel container for storing gasoline.
 - c) Do not fill the fuel tank when the engine is hot or running.
 - d) Fill the fuel tank outdoors and only up to one-half inch from the top of the tank. Do not fill the filler neck.
 - e) Wipe away any spilled gasoline before starting the engine.
- 11) Always be sure of your footing; keep a firm grip on discharge hose when applying spray.
- 12) Use the correct accessories. Do not use the BACK PACK POWER SPRAYER for any job except that for which it is intended.
- 13) Keep all fasteners tight and be sure the BACK PACK POWER SPRAYER is in safe working condition. Follow the maintenance instructions provided in this manual.
- 14) Do not put hands or feet near or under rotating parts. Keep clear at all times.
- 15) If the BACK PACK POWER SPRAYER should start to vibrate abnormally, stop the engine immediately and check for the cause. Vibration is generally a warning of trouble.
- 16) Avoid using the BACK PACK POWER SPRAYER near rocks, gravel, stones and similar matter in order to avoid dangerous flying debris.
- 17) Use the BACK PACK POWER SPRAYER only in daylight or good artificial light.
- 18) Do not allow bystanders in work area.
- 19) Do not operate without guard(s) in place.
- 20) Do not operate in unventilated area.
- 21) To reduce the risk of injury associated with the inhalation of dust, always use a respirator.
- 22) To reduce the risk of injury associated with contacting rotating part, stop the engine before removing attachments.
- 23) To reduce the risk of fire or burn injury:
 - a) Move at least 10ft (3m) away from the fueling point before starting engine.
 - b) always store gasoline in approved container.

SAFETY PRECAUTIONS FOR APPLYING CHEMICALS

Wear appropriate protection when spraying chemicals to eliminate hazard caused by contact with skin or inhalation of chemicals (herbicides, pesticides, ect.). Always wash clothing thoroughly after applying chemicals. Shower with soap and water after applying any chemicals.

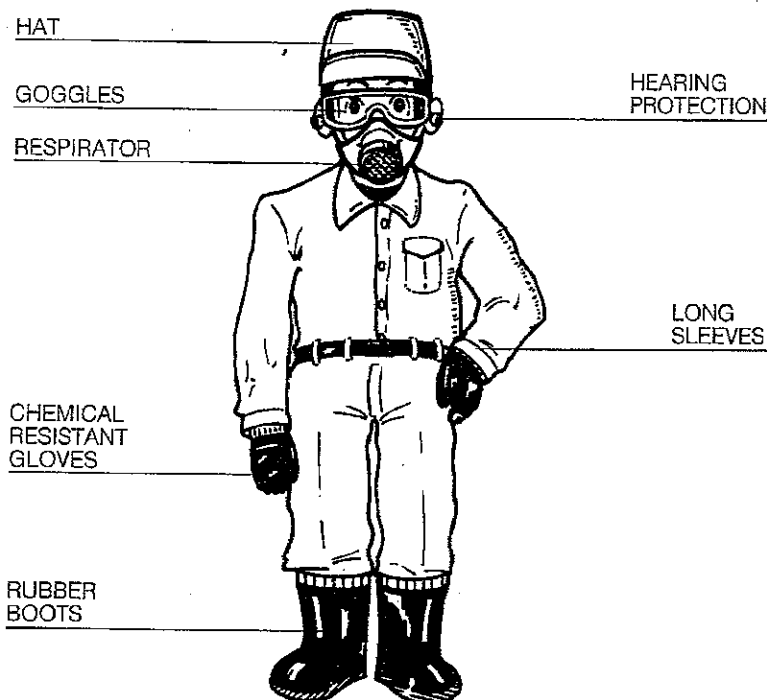

Always read and follow all chemical cautions or handling and usage instructions supplied by the chemical manufacturer. Remember, many chemicals are considered hazardous.

Dispose of chemical containers as instructed on chemical label.

Inspect equipment for loose screws, and damage to parts before starting operation.

Check connections of spray hose, nozzle, ect., for leakage.

Insure proper ventilation when you operate the equipment in a greenhouse or other enclosed area.

Dilute and prepare chemicals in accordance with chemical manufactures instruction.

Make sure the covers of chemical tank and fuel tank are secured.

The MARUYAMA BACK PACK POWER SPRAYER comes with an Owner's / Operator's Manual and a Warranty Registration Card.

ASSEMBLY INSTRUCTIONS

Locate and identify all the components (see sketch)

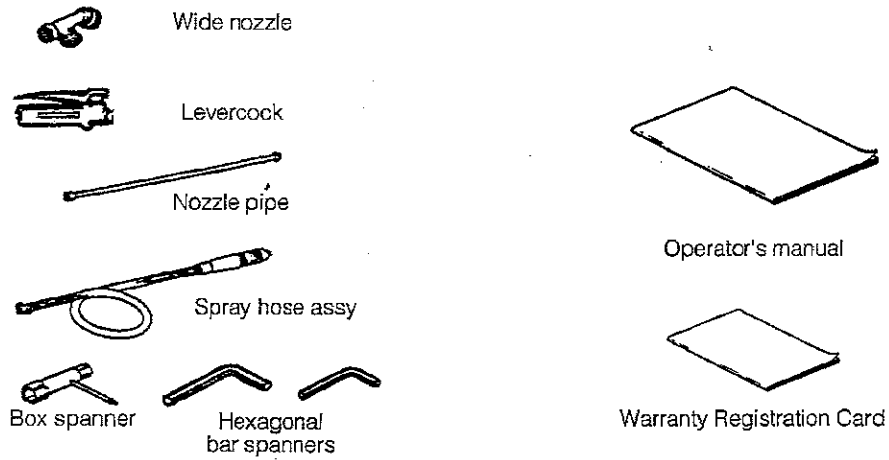

NAMES OF COMPONENTS

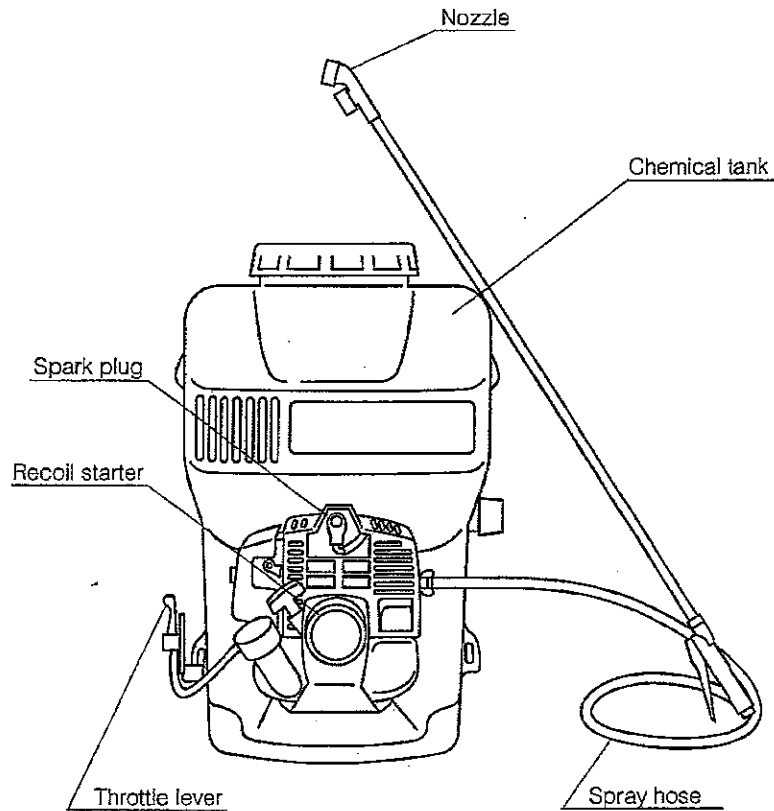

ASSEMBLING

Attach the wide nozzle, the nozzle pipe, the lever cock in that order to the spray hose, and connect the other end of the hose to the spray outlet.

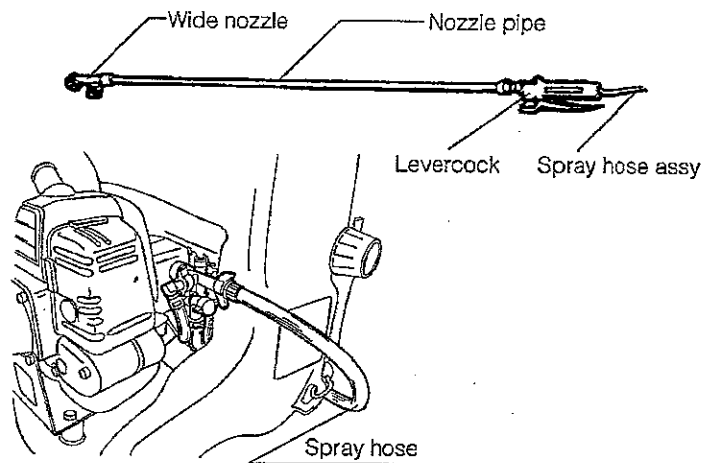

PREPARATIONS FOR STARTING

Check that screws of equipment are not loose.

FUEL

•Always use blended fuel.

Only 2-cycle oil should be used.

gasoline	:	oil
50	:	1

Be sure the engine is stopped and cool.

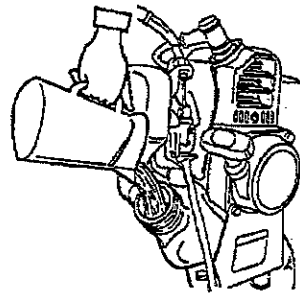

Neither overfill or spill fuel on to the engine.



WARNING: Gasoline is highly flammable and explosive. You can be burned or seriously injured when handling fuel. Stop the engine and keep heat, sparks, and flame away. Handle fuel only outdoors. Wipe up spills immediately.

FUEL: MIXING GASOLINE AND OIL



CAUTION: The engine used on this BACK PACK POWER SPRAYER is of a 2-cycle design. The internal moving parts of the engine, i.e., crankshaft bearings, piston pin bearings and piston to cylinder wall contact surfaces, require oil mixed with the gasoline for lubrication. Failure to add oil to the gasoline or failure to mix oil with the gasoline at the appropriate ratio will cause major engine damage which will void your warranty. For your fuel premix, only use Maruyama 50:1 2-Cycle Oil or a quality oil designed for 2-cycle air-cooled engine.

FUEL MIXTURE: When using genuine Maruyama 50:1 2-Cycle Oil, or a quality oil designed for 2-cycle air-cooled engines, oil ratio is 50 parts gasoline to 1 part oil or 50:1.

FUEL: MIXING GASOLINE AND OIL

⚠ CAUTION: If Maruyama brand oil is not used, never use a mixing ratio less than 50:1 regardless of the oil package mixing instructions. Ratios less than the 50:1, (for example, 60:1, 80:1, 100:1), reduce the amount of lubrication to the internal moving parts of the engine and can cause damage.

Gasoline	50:1 2-Cycle Oil
1 gallon	2.6 oz.
2 1/2 gallons	6.4 oz.
5 gallons	12.8 oz.

MIXING INSTRUCTIONS: Always mix fuel and oil in a clean container approved for gasoline. Mark the container to identify it as fuel mix for the BACK PACK POWER SPRAYER. Use regular unleaded gasoline and fill the container with half the required amount of gasoline. Pour the correct amount of oil into the container then add the remaining amount of gasoline. Close the container tightly and shake it momentarily to evenly mix the oil and the gasoline before filling the fuel tank on the BACK PACK POWER SPRAYER.

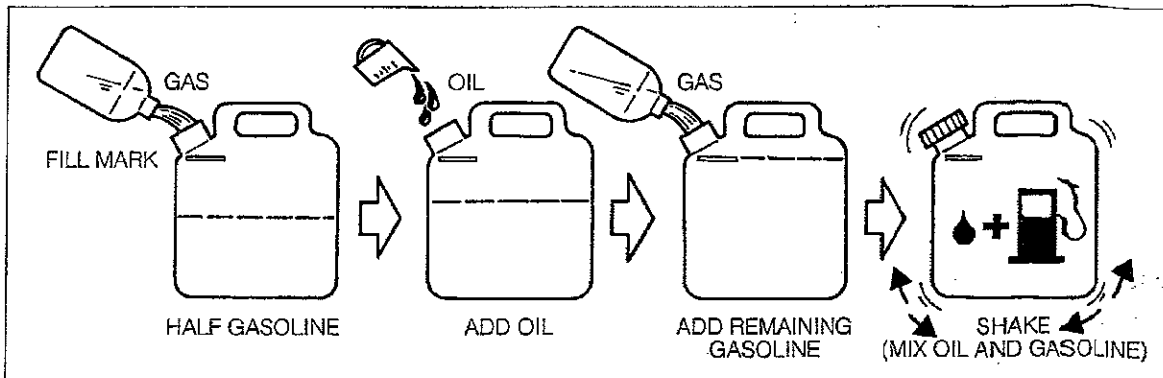

When refilling the BACK PACK POWER SPRAYER fuel tank, clean around the fuel tank cap to prevent dirt and debris from entering the tank during cap removal. Always shake the premix fuel container momentarily before filling the fuel tank.

Always use a spout or funnel when fueling to reduce fuel spillage. Only fill the tank to within 1/4-1/2 inch from the top of the tank. Avoid filling to the top of the tank filler neck.

NOTE:

1. Never mix gasoline and oil directly in the BACK PACK POWER SPRAYER fuel tank.

⚠ CAUTION

1. Do not use National Marine Manufacturer's Association (NMMA) or BIA certified oils. This type of 2-cycle engine oil does not have the proper additives for air-cooled, 2-cycle engines and can cause engine damages.
2. Do not use automotive motor oil. This type of oil does not have the proper additives for air-cooled, 2-cycled engines and can cause engine damage.

OPERATING INSTRUCTIONS

CHARGING PROCEDURE FOR CHEMICAL LIQUID

Dilution of chemicals/Charging to the chemical tank



CAUTION: Agricultural chemicals are extremely dangerous, and must be handled with care. Read chemical instructions carefully before use.

Dissolve water dispersible powder in a separate container before filling. Be sure not to get foreign material into the chemicals.

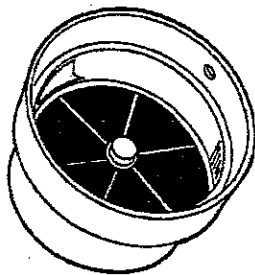

Always fill the chemical tank through the strainer so that contaminants are not mixed into the chemicals.

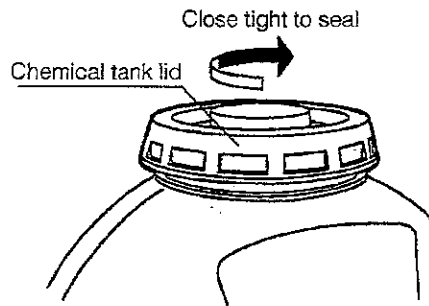

Before spraying the agrochemical, be sure to put on suitable protective clothing to protect yourself against contact with and breathing it. Observe the following cautions for safe operation:

- a) Be sure to close the chemical tank cover securely.
- b) Check the spray hose and nozzle connections to make sure there are no
- c) Always stop the engine before refilling the fuel tank or changing the nozzle.
- d) When carrying a full chemical tank, be careful not to lose your balance.



CAUTION

- 1) If the pump is operated without the pickup hose being submerged in solution it will cause damage to the pump and or mechanical seal. Do not run the pump without liquid, except when draining, and immediately stop the engine.
- 2) When chemical is depleted, stop the engine to prevent pump damage.
- 3) When the spraying condition is not satisfactory, increase the engine speed, or remove and clean the nozzle. Replace the orifice disk with a new disk if there are any signs of wear or damage.
- 4) When the engine is operated continuously at a low or medium speed for a long time carbon deposits will build up on top of the piston and in the exhaust port. Therefore, occasionally run up to high speed to help remove carbon deposits. Removal of carbon deposits should be performed as regular maintenance.

OPERATING INSTRUCTIONS

STARTING PROCEDURE FOR ENGINE

STEP #1) Pump the "PRIMER BULB" under of the carburetor until fuel can be seen flowing through the "FUEL-RETURN LINE".

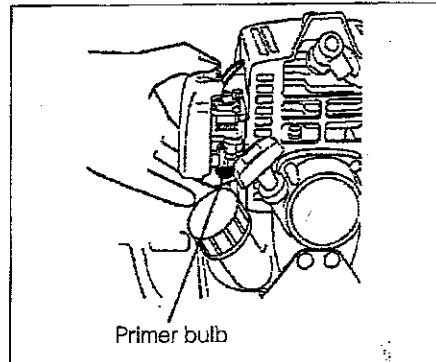

STEP #2) Move the "CHOKE LEVER" fully upward to the closed position. If the engine is already warm, use of the choke may not be required.

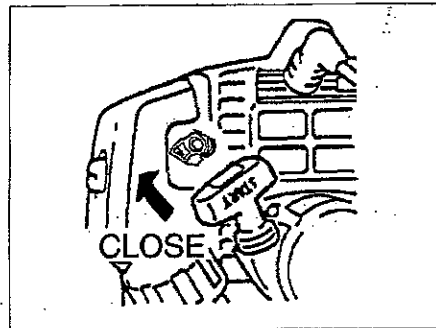

STEP #3) Turn the stop switch ON. (Confirm that the stop switch is at the starting position.)

STEP #4) Set the throttle lever at 1/2 speed.

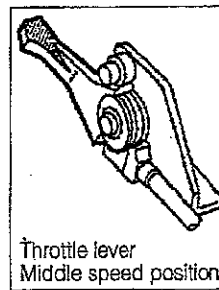

STEP #5) Warming up the engine.
When the engine has started, slowly move the "CHOKE LEVER" fully downward to the open position. Allow the engine to "WARM-UP" at less than 1/2 speed.

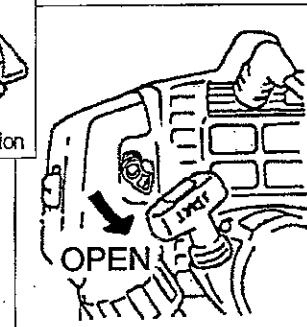

If a MARUYAMA engine fails to start after following the above procedures, contact an authorized MARUYAMA dealer.

CAUTION

Do not start engine if there is not liquid in the chemical tank.

Pull the "STARTER GRIP" briskly to start the engine.

NOTE: Only short pulls are necessary. Never pull the starter cord to its fullest extension. Never let go of the starter grip until it is at the fully returned position.

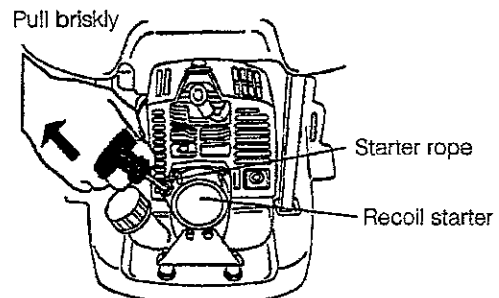

OPERATION

When the engine has warmed-up, the BACK PACK POWER SPRAYER can be positioned on the back of the operator.

When the BACK PACK POWER SPRAYER is positioned and ready for operation, adjust the throttle to a speed required to accomplish the task.

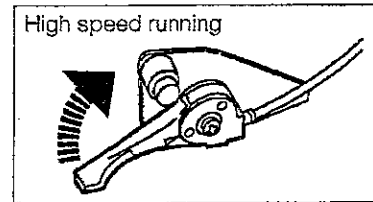

! WARNING

- Never operate a BACK PACK POWER SPRAYER when you are fatigued.
- Never operate a BACK PACK POWER SPRAYER without proper guards or other protective safety devices in place.

STOPPING THE ENGINE

Always run the engine at idle speed for a few minutes to allow cooling before stopping. To stop the engine, move the throttle control lever all the way to the engine idle position, then push the stop switch.

Temporary stop during operation

- a) Close the nozzle, and return the throttle lever to low speed.
- b) Press the engine stop button.
- c) After the engine stops, set the sprayer down and close the fuel cock.

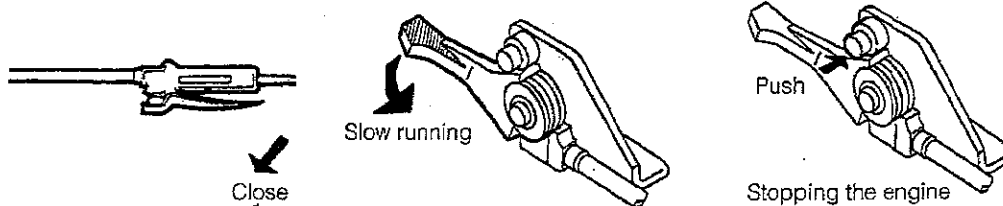

REGULAR MAINTENANCE

Before each use, the BACK PACK POWER SPRAYER should be inspected for proper assembly and fitness of all components. All fasteners should be checked for correct tightness. Always inspect for fuel leaks.

! WARNING Do not attempt to start or operate a BACK PACK POWER SPRAYER that indicates a fuel leak.

AIR FILTER

The air filter should be inspected each time the BACK PACK POWER SPRAYER is used (or more often with extreme conditions).

To inspect, remove the air filter cover and remove the filter from the case.

Clean air filter(s) and the cover with compressed air or wash the filter(s) in a suitable cleaning solution.

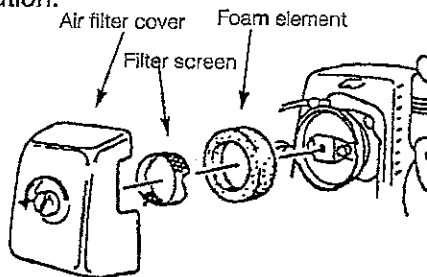

Remove the air filter cap to clean the element

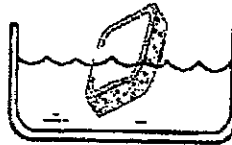

Detergent and water

Add several drops of 2 cycle oil to filter.



Squeeze firmly

SPARK PLUG

The spark plug should be removed from the engine and checked after each fifty (50) hours of use. The tips can be cleaned with a stiff brush. Adjust the gap to 0.024 - 0.028 inches (see sketch). Replace the spark plug if it is oil-fouled or damaged.

! CAUTION

The correct torque for the spark plug is 10 - 12 ft. lbs.
Do not over-tighten.

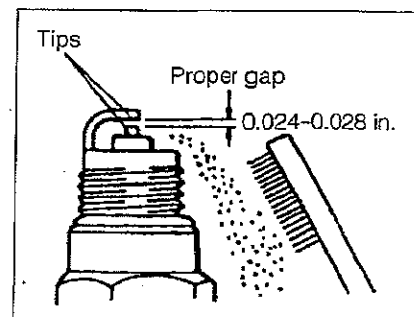

FUEL FILTER

The fuel filter should be cleaned and inspected for damage after each twenty (20) hours of use. The fuel filter is attached to the fuel pick-up tube inside the fuel tank. Loosen the clamp and take out the fuel filter.

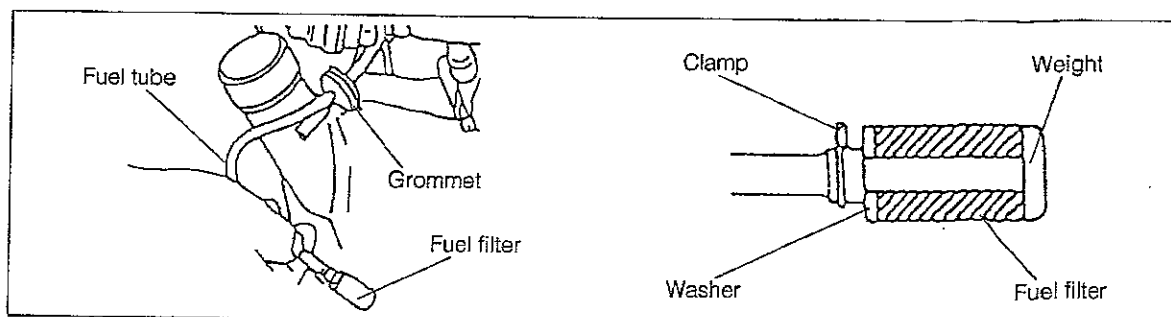

If fuel filter is contaminated, replace fuel filter. Inspect and clean the fuel tank before re-installing the fuel filter.

Always replace a defective fuel filter.

COOLING FINS

Free passage of air through the cylinder cooling fins is required to prevent poor engine performance and shortened engine life. Regularly check and clean all debris from the cooling fins by removing the engine cover.

MUFFLER AND EXHAUST PORTS

The muffler should be removed and serviced after each one hundred (100) hours of use. At the same time, the exhaust ports should be cleaned and inspected. An AUTHORIZED MARUYAMA DEALER should be contacted for this service.

GENERAL CLEANING AND TIGHTENING

The MARUYAMA power sprayer will provide maximum performance for many hours, if it is maintained properly. Good maintenance includes regular checking of all fasteners for correct tightness, and cleaning the entire machine. Contact an authorized MARUYAMA dealer for additional maintenance suggestions.

CLEANING NOZZLE AND BYPASS HOSE

The nozzle and bypass hose may be cleaned after each 50 hours of use. (see sketch)

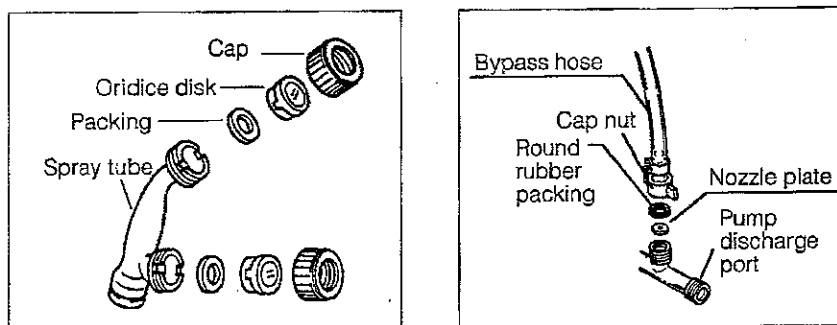

STORAGE

For long-term storage of the BACK PACK POWER SPRAYER, first perform all regular maintenance procedures and needed repairs. Empty the fuel tank. Disconnect the fuel supply line from the carburetor and depress the primer bulb until fuel stops discharging from the fuel-return line.

Start the engine and allow it to run until it stops. Pull the starter cord a few times to remove any excess fuel from the engine. Remove the spark plug and insert a small amount of oil into the cylinder. Slowly pull the starter cord and bring the piston to a position closest to the spark plug hole. Re-install the spark plug. Apply a thin coating of oil to all the metal surfaces and store the power blower in a dry place.

Clean chemical tank.

EMISSION CONTROL INFORMATION

FUEL INFORMATION

THIS ENGINE IS CERTIFIED TO OPERATE ON UNLEADED REGULAR GRADE GASOLINE ONLY. A minimum of 87 octane of the antiknock index is recommended. The antiknock index is posted on service station pumps in the U.S.A..

EMISSION CONTROL INFORMATION

To protect the Environment in which we all live, MARUYAMA has incorporated exhaust emission control system (EM) in compliance with applicable regulations of the California Air Resources Board.

EXHAUST EMISSION CONTROL SYSTEM (EM)

The exhaust emission control system applied to this engine consists of a carburetor and an ignition system having optimum ignition timing characteristics.

The carburetors have been calibrated to provide lean air/fuel mixture characteristics and optimum fuel economy with a suitable air cleaner and exhaust system.

MAINTENANCE AND WARRANTY

Proper maintenance is necessary to ensure that your engine will continue to have low emission levels. This Owner's Manual contains those maintenance recommendations for your engine. Those items identified by the Periodic Maintenance Chart are necessary to ensure compliance with the applicable standards.

The Maruyama Limited Emission Control System Warranty requires that you return your engine to an authorized Maruyama engine Dealer for remedy under warranty. Please read the warranty carefully, and keep it valid by complying with the owner's obligations it contains.

TAMPERING WITH EMISSION CONTROL SYSTEM PROHIBITED

California State law prohibits the following acts or the causing there of: (1) the removal or rendering inoperative by any person other than for purposes of maintenance, repair, or replacement, of any device or element of design incorporated into any new engine for the purposes of emission control prior to its sale or delivery to the ultimate purchaser or while it is in use, or (2) the use of the engine after such device or element of design has been removed or rendered inoperative by any person.

Among those acts presumed to constitute tampering are the acts listed below:

Do not tamper with the original emission related parts:

- Carburetor and internal parts
- Spark Plug
- Magnet or electronic ignition system
- Fuel Filter
- Air cleaner element

FUEL RECOMMENDATIONS

FUEL

MARUYAMA AE230 2-stroke engine require a gasoline-oil mixture.
Use only clean, fresh, unleaded regular grade gasoline.

Octane Rating

The octane rating of a gasoline is a measure of its resistance to "knocking".
Use a minimum of 87 octane of the antiknock index is recommended. The antiknock index is posted on service station pumps in the U.S.A.

NOTE:

- If "knocking or pinging" occurs, use a different brand of gasoline or higher octane rating.

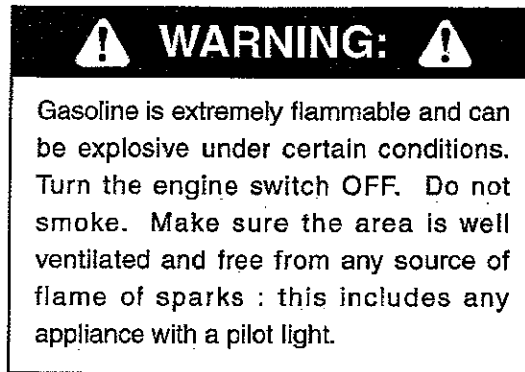

2-STROKE ENGINE OIL MIXING

Oil must be mixed with the gasoline to lubricate the piston, cylinder, crankshaft, bearings, and connecting rod bearings.

Recommended Engine Oil: 2-stroke air cooled brand oil

Gasoline and engine oil mixing ratio: 50 : 1 (gasoline 50, 2-stroke Engine Oil 1)

NOTE:

- Do not mix gasoline and oil directly in the fuel tank.
- Do not use gasoline that has been stored longer than two month.
- To ensure proper starting at low ambient temperatures, fresh winter grade fuel must be used.

 **CAUTION** The engine is shipped without fuel.

ADJUSTMENT

IDLING SPEED ADJUSTMENT

1. Idle speed is the only available adjustment.
2. Do not tamper with the carburetor setting to increase the maximum engine speed.
3. If adjustment is needed, have it performed by your authorized MARUYAMA engine dealer.
Carburetor adjustments are made at the factory and are not adjustable without disassembling the carburetor.

MAINTENANCE

PERIODIC MAINTENANCE CHART

⚠ WARNING: ⚠

Always remove the spark plug cap from spark plug when servicing the engine to prevent accidental starting.

MAINTENANCE	Interval				
	Daily	First 20 hours	Every 20 hours	Every 50 hours	Every 100 hours
Check and replenish fuel	●				
Check for fuel leakage	●				
Check bolts, nuts and screws for looseness and loss	●				
Clean fuel filter			●		
★ Clean/Inspect air filter element	●		●		
Clean spark plug and adjust electrode gap				●	
★ Remove dust and dirt from cylinder fins				●	
M Remove carbon deposits on piston head and inside cylinder				●	
M Remove carbon deposits in the exhaust pipe of muffler				●	
M Clean net of spark arrester (if equipped)				●	
M Check the sliding portion of crankshaft, connecting rod etc.					●
Fuel tube	It is recommended to replace every 3 years.				

Note: The service intervals indicated are to be used as a guide. Service to be performed more frequently as necessary by operating condition.

M: Service to be performed by an authorized Maruyama engine dealer.

: Service more frequently under dusty conditions.

★

TROUBLE SHOOTING

When engine fails to start:

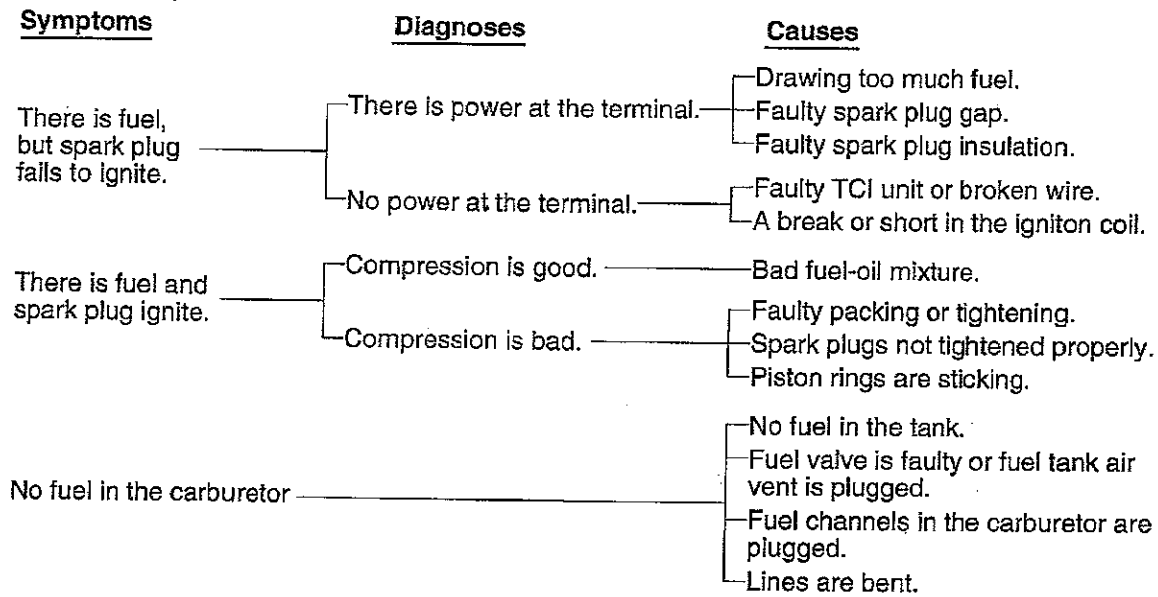

Engine fails to run smooth:

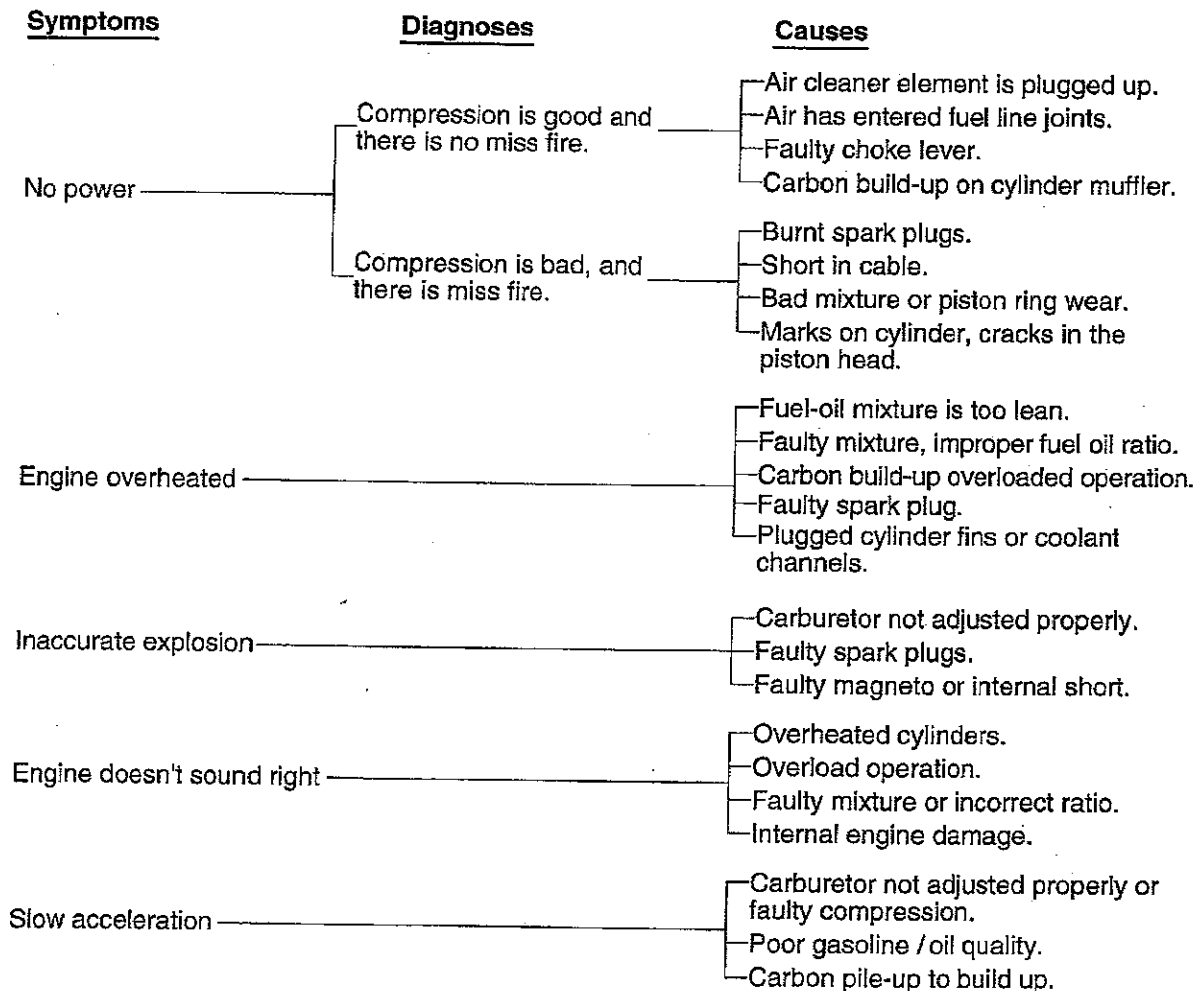

Pump:

Symptoms

Cause

Countermeasure

Does not pick up liquid	Loose joint of suction hose.	Tighten sufficiently.
	Suction hose is clogged.	Disassemble and dislodge obstruction.
Poor spray condition	Worn nozzle hole.	Replace with new parts.
	The nozzle clogged with contaminants.	Disassemble and clean.
	Too many nozzles used.	Reduce number of nozzle, or replace with nozzles of lower output.
	Low rotational speed.	Increase rotational speeds up to normal
Liquid leakage from under side between engine and pump	Worn impeller and pump.	Disassemble and clean.
	Worn mechanical seat.	Replace with new parts.
	Pump failure.	Replace with new parts.

SPECIFICATIONS

Dimension	
Height*Width*Length (mm)	560*415*335
Dry weight (kg)	7.0
Chemical tank capacity (liter)	15
Fuel tank capacity (liter)	0.5
Pump	
Type	centrifugal pump
Maximum pressure (kgf/cm ²)	5~10
Suction (liter/min)	1.5~7
Rotational frequency (rpm)	4000~8000
Engine	
Model	MARUYAMA AE230
Type	Forced Air Cool, 2-cycle
Displacement (cc)	22.5
Rated continuous output (PS/rpm)	0.65/6500
Fuel	Mixed gasoline (50 : 1)
Ignition system	Electronic Ignition
Spark plug	NGK BPM6Y
Starting system	Recoil starter

Specification may be changed for product improvement, without prior notice.